

**Features:**

- 4 Panel Array
- Broad Band Coverage
- 4.4 - 5.0 GHz
- 14 dBi Gain Per Panel
- Rugged Polycarbonate Radome
- 90 Degree Elements
- Can be used with customer-provided Block Downconverter (not included)



**Antenna Specifications**

Parameter	Value	Units	Tolerance
Frequency Band	C		
Impedance	50	Ohms	
Minimum Frequency	4.4 / 4,400	GHz / MHz	
Maximum Frequency	5.0 / 5,000	GHz / MHz	
Frequency Bandwidth	0.6 / 600	GHz / MHz	
Maximum VSWR	2:1	Ratio	
Maximum Gain	14	dBi	
Polarization	Vertical		
Horizontal (AZ) Beamwidth	90	Degrees	
Vertical (EL) Beamwidth	31	Degrees	
Color	White		
Mount Style	Pole Mount		

Parameter	Value	Units	Tolerance
<b>Maximum Wind Velocity</b>	99 / 160	mph / kph	
<b>RF Connector Type</b>	TNC(f)		
<b>Product Height</b>	19.15 / 486.41	inches / mm	
<b>Product Diameter</b>	12.12 / 307.85	inches / mm	

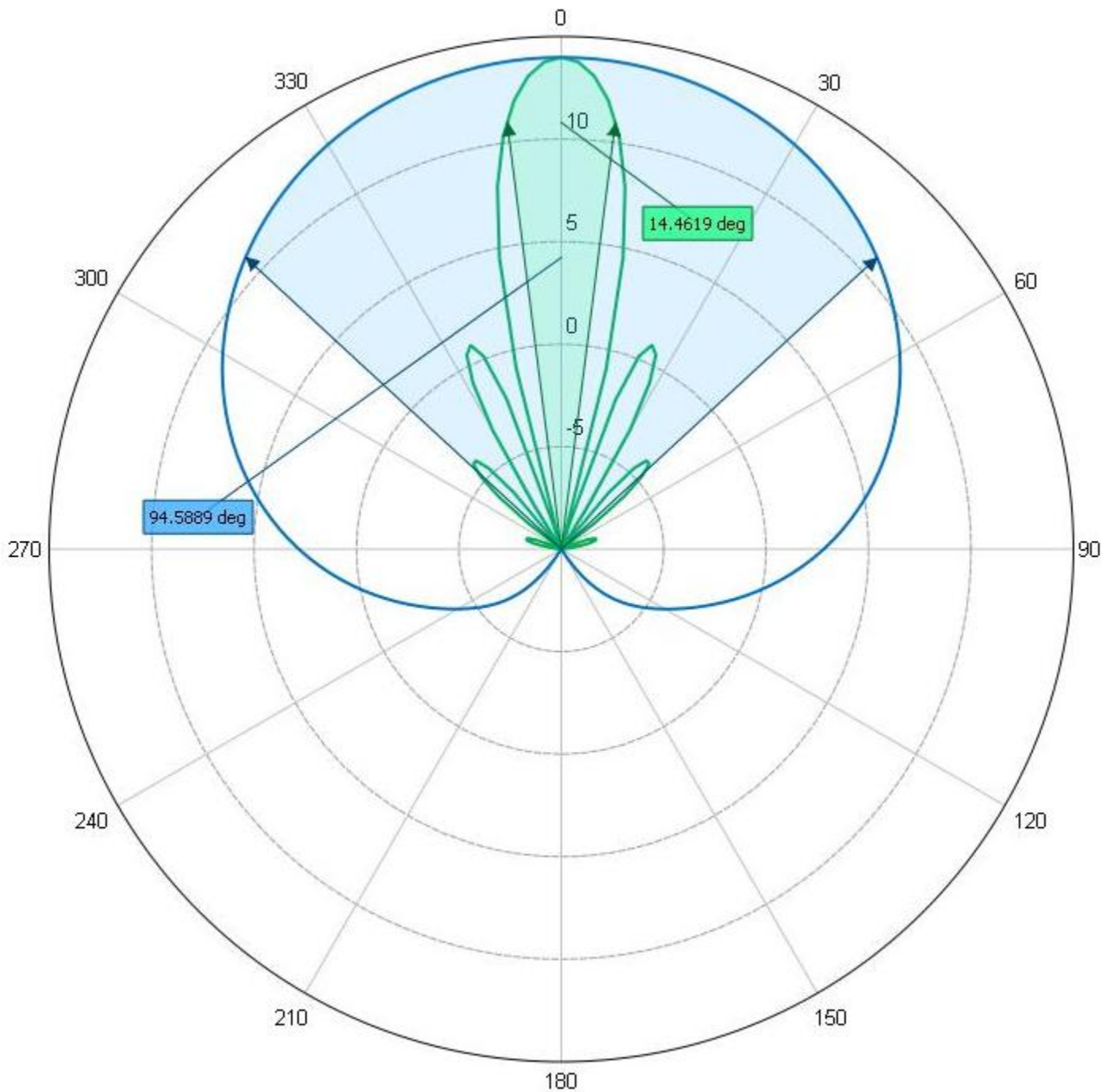

**Azimuth Pattern**

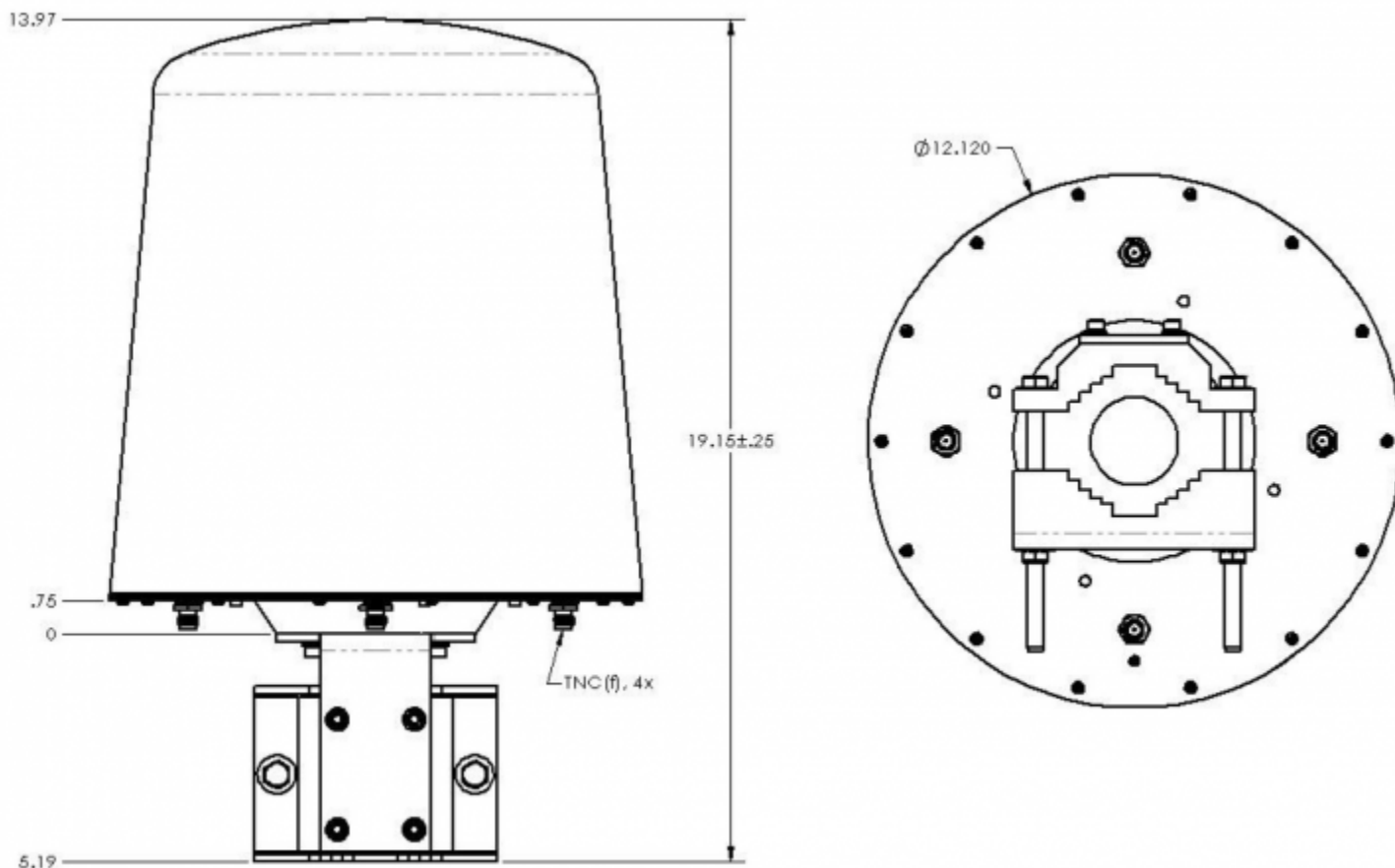

**Engineering Drawing**

Dimensions are in inches